

MPEG Clock Generator with VCXO

Features

- Integrated phase-locked loop (PLL)
- Low-jitter, high-accuracy outputs
- VCXO with analog adjust
- 3.3V operation

Benefits

- Highest-performance PLL tailored for multimedia applications
- Meets critical timing requirements in complex system designs
- Application compatibility for a wide variety of designs

Table 1. Frequency Table

Part Number	Outputs	Input Frequency Range	Output Frequencies	VCXO Control Curve	Other Features
CY241V08A-11	1	13.5-MHz pullable crystal input per Cypress specification	One copy of 54 MHz	linear	Pinout-compatible with CY2411

Block Diagram

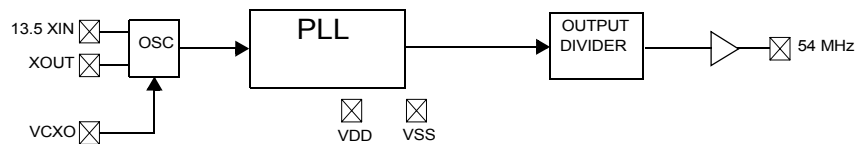

Pin Configuration

CY241V08A-11 8-pin SOIC

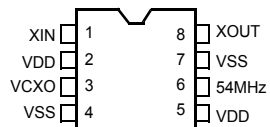

Pin Descriptions

Name	Pin Number	Description
XIN	1	Reference crystal input.
VDD	2,5	Voltage supply.
VCXO	3	Input analog control for VCXO.
VSS	4,7	Ground.
54MHz	6	54MHz clock output.
XOUT	8	Reference crystal output.

Absolute Maximum Conditions

Supply Voltage (V_{DD})-0.5 to +7.0V
 DC Input Voltage -0.5V to $V_{DD} + 0.5$
 Storage Temperature (Non-condensing).....-55°C to +125°C
 Junction Temperature -40°C to +125°C

Data Retention @ $T_j = 125^\circ\text{C}$> 10 years
 Package Power Dissipation 350 mW
 ESD (Human Body Model) MIL-STD-883..... > 2000V
 (Above which the useful life may be impaired. For user guide-
 lines, not tested.)

Pullable Crystal Specifications^[1]

Parameter	Description	Comments	Min.	Typ.	Max.	Unit
F_{NOM}	Nominal crystal frequency	Parallel resonance, fundamental mode, AT cut	-	13.5	-	MHz
C_{LNOM}	Nominal load capacitance		-	14	-	pF
R_1	Equivalent series resistance (ESR)	Fundamental mode	-	-	25	Ω
R_3/R_1	Ratio of third overtone mode ESR to fundamental mode ESR	Ratio used because typical R_1 values are much less than the maximum spec	3	-	-	-
DL	Crystal drive level	No external series resistor assumed	150	-	-	μW
F_{3SEPHI}	Third overtone separation from 3^*F_{NOM}	High side	300	-	-	ppm
F_{3SEPLO}	Third overtone separation from 3^*F_{NOM}	Low side	-	-	-150	ppm
C_0	Crystal shunt capacitance		-	-	7	pF
C_0/C_1	Ratio of shunt to motional capacitance		180	-	250	-
C_1	Crystal motional capacitance		14.4	18	21.6	fF

Recommended Operating Conditions

Parameter	Description	Min.	Typ.	Max.	Unit
VDD	Operating Voltage	3.135	3.3	3.465	V
T_A	Ambient Temperature	0	-	70	$^\circ\text{C}$
C_{LOAD}	Max. Load Capacitance	-	-	15	pF
t_{PU}	Power-up time for all V_{DD} pins to reach minimum specified voltage (power ramps must be monotonic)	0.05	-	500	ms

DC Electrical Specifications

Parameter	Name	Description	Min.	Typ.	Max.	Unit
I_{OH}	Output HIGH Current	$V_{OH} = V_{DD} - 0.5\text{V}$, $V_{DD} = 3.3\text{V}$	12	24	-	mA
I_{OL}	Output LOW Current	$V_{OL} = 0.5\text{V}$, $V_{DD} = 3.3\text{V}$	12	24	-	mA
C_{IN}	Input Capacitance	Except XIN, XOUT pins	-	-	7	pF
V_{VCXO}	VCXO Input Range		0	-	V_{DD}	V
$f_{\Delta XO}^{[2]}$	VCXO Pullability Range	Low Side	-	-	-115	ppm
		High Side	115	-	-	ppm
I_{VDD}	Supply Current		-	30	35	mA

AC Electrical Specifications ($V_{DD} = 3.3\text{V}$)^[3]

Parameter ^[3]	Name	Description	Min.	Typ.	Max.	Unit
DC	Output Duty Cycle	Duty Cycle is defined in <i>Figure 1</i> , 50% of V_{DD}	45	50	55	%
ER	Rising Edge Rate	Output Clock Edge Rate, Measured from 20% to 80% of V_{DD} , $C_{LOAD} = 15\text{ pF}$. See <i>Figure 2</i> .	0.8	1.4	-	V/ns
EF	Falling Edge Rate	Output Clock Edge Rate, Measured from 80% to 20% of V_{DD} , $C_{LOAD} = 15\text{ pF}$. See <i>Figure 2</i> .	0.8	1.4	-	V/ns
t_g	Clock Jitter	Peak-to-peak period jitter	-	-	100	ps
t_{10}	PLL Lock Time		-	-	3	ms

Notes:

- Crystals that meet this specification include: Ecliptek ECX-5788-13.500M, Siward XTL001050A-13.5-14-400, Raltron A-13.500-14-CL, PDI HA13500XFSA14XC.
- 115/+115 ppm assumes 2.5pF of additional board level load capacitance. This range will be shifted down with more board capacitance or shifted up with less board capacitance.
- Not 100% tested.

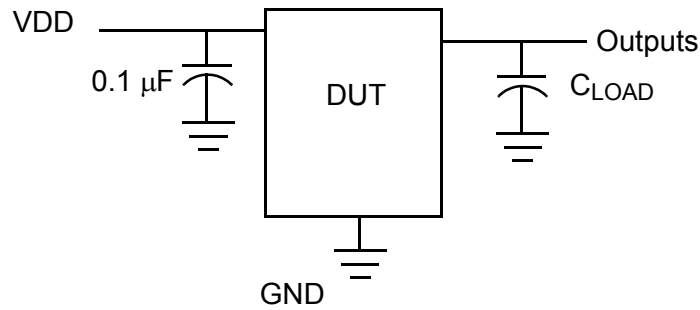
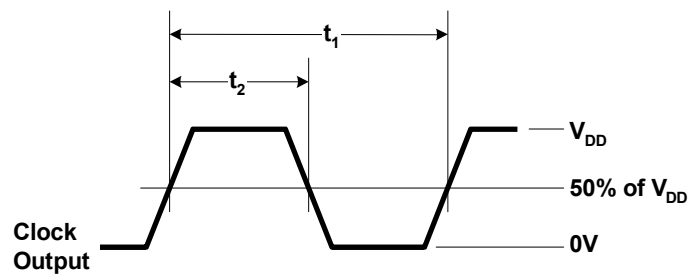
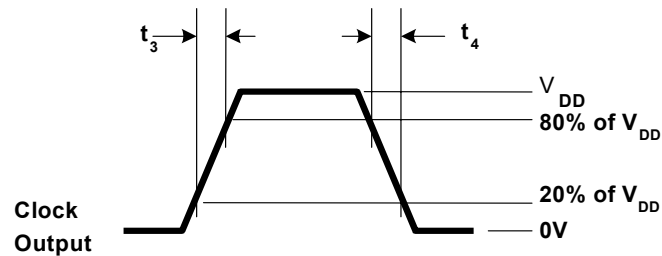
Test and Measurement Set-up

Voltage and Timing Definitions

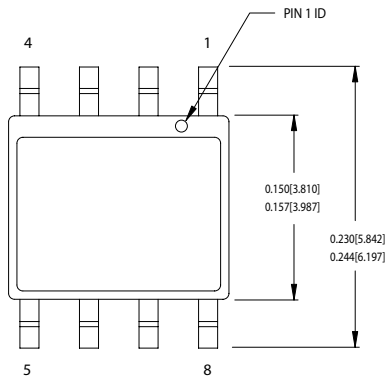
Figure 1. Duty Cycle Definition

Figure 2. $ER = (0.6 \times V_{DD}) / t_3$, $EF = (0.6 \times V_{DD}) / t_4$
Ordering Information

Ordering Code	Package Name	Package Type	Operating Range	Operating Voltage	Features
CY241V08ASC-11	S8	8-pin SOIC	Commercial	3.3V	Linear VCXO control curve
CY241V08ASC-11T	S8	8-pin SOIC – Tape and Reel	Commercial	3.3V	Linear VCXO control curve

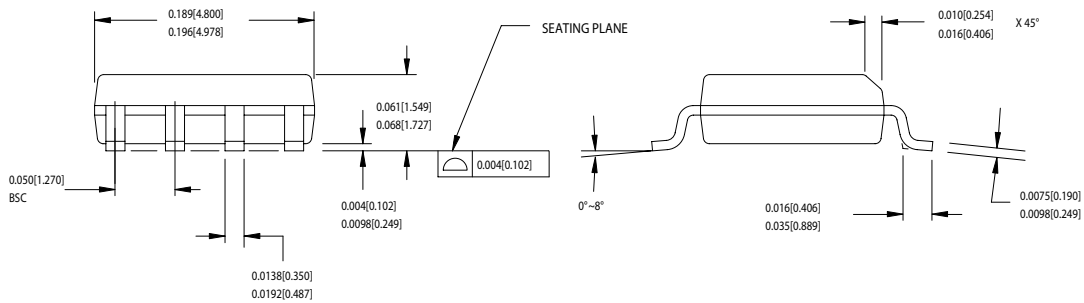
Package Drawing and Dimensions
8-lead (150-Mil) SOIC S8

1. DIMENSIONS IN INCHES[MM] MIN. MAX.
2. PIN 1 ID IS OPTIONAL,
ROUND ON SINGLE LEADFRAME
RECTANGULAR ON MATRIX LEADFRAME
3. REFERENCE JEDEC MS-012
4. PACKAGE WEIGHT 0.07gms

PART #
S08.15 STANDARD PKG.
SZ08.15 LEAD FREE PKG.



51-85066-°C

All product or company names mentioned in this document may be the trademarks of their respective holders.

Document History Page

Document Title: CY241V08A-11 MPEG Clock Generator with VCXO Document Number: 38-07654				
REV.	ECN NO.	Issue Date	Orig. of Change	Description of Change
**	214071	See ECN	RGL	New Data Sheet
*A	220461	See ECN	RGL	Minor Change: To post on web